

Overview

The DXLink Multi-Format Wallplate TX and DXLink Multi-Format Decor Style Wallplate TX are used in conjunction with switchers that support DXLink Technology for transmission of HDMI or analog video over twisted pair cable. Both TXs are compatible with the DXLink HDMI RX and support InstaGate Pro® Technology. The *Hardware Reference Manual – DXLink Twisted Pair Transmitters /Receiver* contains complete documentation (including full specifications and supported input and output resolutions); for details, see www.amx.com.

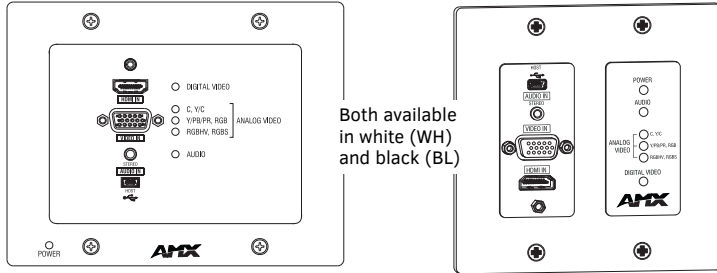

FIG. 1 WALLPLATE TX: FG1010-320-WH (LEFT) AND DECOR TX: FG1010-325-WH (RIGHT)

Installation

System Setup

These Transmitters receive an HDMI signal (or DVI via a cable adapter) or an analog video signal plus an audio signal from the source device. The audio can be either digital audio embedded with the HDMI signal or analog stereo audio. Both the video and audio are transmitted over twisted pair cable to a DXLink Input Board in a switcher that supports DXLink Technology (see the example in FIG. 2). From the Input Board, the signal can be routed through an output board. If the output board is a DXLink Output Board, a DXLink HDMI RX is required between the board and the destination.

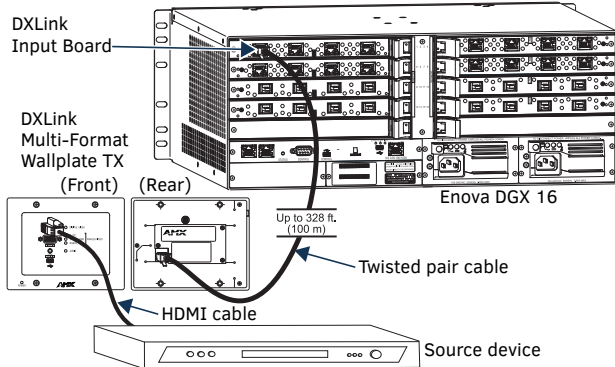

FIG. 2 WALLPLATE TX (FRONT & REAR) USED W/DXLINK INPUT BOARD IN ENOVA DGX 16

DIP Switch #3 Toggle

Before mounting the Transmitter – If a network connection is required, DIP switch #3 Toggle must be set to ON. #3 Toggle is shipped in the OFF position. When flipped ON (up), the Transmitter will attempt a DHCP connection. Flipping the #3 Toggle ON is the only way to access the Wallplate TX and Decor TX in NetLinX Studio. For both types of Transmitters, #1, #2, and #4 Toggles are non-functional (must remain OFF). For Auto-setup with an Enova DGX 100 Series Switcher, set #3 Toggle to OFF and see the switcher’s manual.

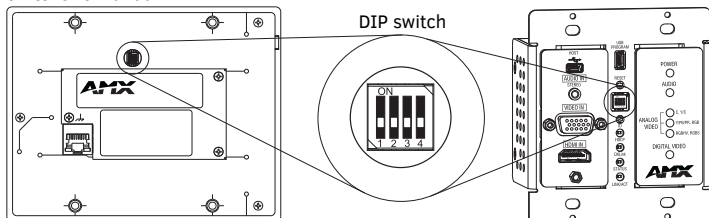

FIG. 3 DIP SWITCH ON REAR OF WALLPLATE TX (LEFT); ON FRONT OF DECOR TX (RIGHT)

IP Addressing Modes

DHCP Mode (enabled when #3 Toggle is flipped ON)

In DHCP Mode, the Transmitter attempts to get a DHCP lease (consisting of an IP address, gateway, and other network parameters). If the attempt fails, the Transmitter configures itself for a link-local address, but periodically re-tries DHCP and re-assigns the IP to a valid DHCP grant if successful. At any time, if the Transmitter determines that its IP address has changed, it will disconnect and reconnect to the Master.

Static IP Mode (set with ID button or Telnet command)

With #3 Toggle set to ON, press ID for 10 seconds to assign an address of 192.168.1.2 or use a Telnet command to set unit to Static IP Mode (see the *Hardware Reference Manual*).

Mounting the Wallplate TX and Decor Wallplate TX

Wallplate TX – The holes in the Wallplate TX mounting bracket are designed to accommodate a variety of gang boxes using 2 or 4 screws (standard and metric are provided). Be sure to orient mounting bracket as shown in FIG. 4.

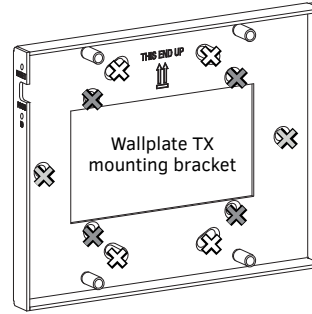

Use screw holes indicated with “X”s below:

- ✕ US flush mount inside wall
- ✕ EU flush mount inside wall
- ✕ UK surface mount exterior wall or
- ✕ UK flush mount inside wall

FIG. 4 WALLPLATE TX MOUNTING BRACKET

Decor Wallplate TX – The Decor Wallplate TX mounts into a standard US double-gang back box. *Decor style front cover plate is customer provided.*

Technical Ground

If the system is experiencing problems with delivery of DXLink signals to/from an Enova DGX Digital Media Switcher or Enova DVX Solution, adding a ground wire from the TX/RX to the switcher may improve performance (see FIG. 7 on the next page). Technically this type of grounding is only required when a DXLink Transmitter or Receiver is connected to an ungrounded device, but this added grounding measure can be used at the discretion of the installer (for instructions, see the *Hardware Reference Manual*).

Twisted Pair Cable Pinouts and RJ-45 LEDs

The DXLink port (RJ-45 connector) on the rear of the Transmitters uses twisted pair cable. FIG. 5 shows two pinouts that can be used. FIG. 6 shows LEDs for the port.

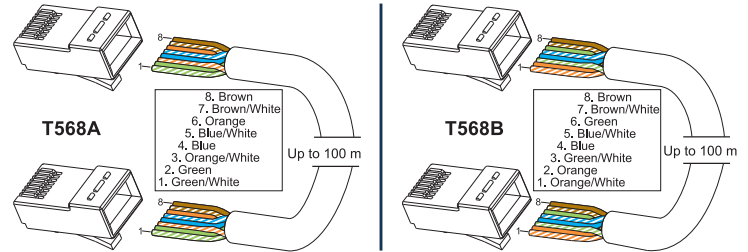

FIG. 5 RJ-45 CONNECTOR PINOUTS

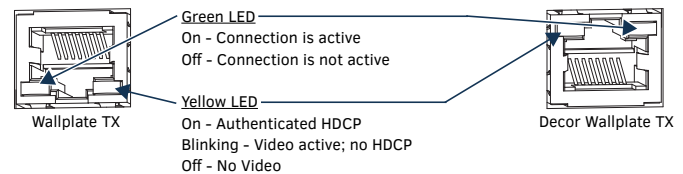

FIG. 6 DXLINK PORT LEDs

Before installing the Transmitter:

- ❑ Wallplate TX – remove mounting bracket.
- ❑ If a network connection is required, set #3 Toggle to ON.
- ❑ If gang box is not already installed, install it now.

To install the Wallplate Tx:

1. Attach the Wallplate TX mounting bracket to the gang box.
2. Attach a twisted pair cable from the DXLink Input Board on the switcher through the mounting bracket to the DXLink connector on rear of Wallplate TX (FIG. 7).
3. Reattach the unit to the mounting bracket.

To install the Decor Wallplate TX:

1. Attach a twisted pair cable from the DXLink Input Board on the switcher to the DXLink connector on the rear of the Decor Wallplate TX.
2. Attach unit to back box with four screws through the large screw holes.
3. Check LEDs for normal display (see table on the next page).

4. Attach customer-provided decor style front cover plate to the unit.

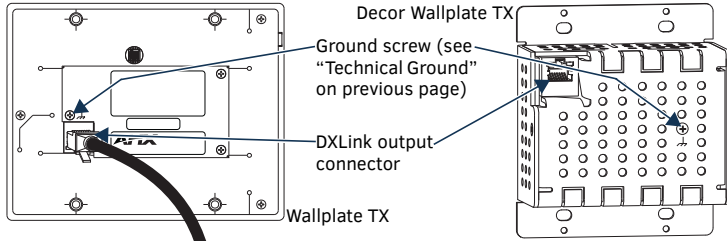

FIG. 7 CONNECT TWISTED PAIR CABLE TO DXLINK CONNECTOR ON TX (WALLPLATE TX SHOWN)

IMPORTANT: Do not use the RJ-45 connector on rear of the Transmitter to connect to a standard Ethernet Network. Use this connector for signal transport only.

Attaching Signal and Control Cables

IMPORTANT: Transmitters must be securely mounted and connected to the switcher before attaching the remaining cables.

To attach cables to the Transmitter:

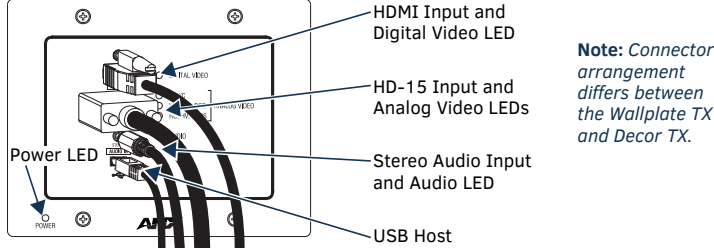

FIG. 8 ATTACH SIGNAL AND CONTROL CABLE (WALLPLATE TX SHOWN)

1. HDMI input – Attach an HDMI cable from source to HDMI In connector.
2. Analog video input – Attach HD-15 cable from source to analog video connector.
3. Stereo jack (optional) – Insert analog audio cable from source into Stereo jack.
4. USB Host (optional) – Attach USB cable from PC to USB (mini-B) port.
5. If necessary, set the video and audio formats using SEND_COMMANDS (see the *Hardware Reference Manual*).
6. Check LEDs for normal display (see table in right-hand column).

NOTE: Use DVI cable via an adapter (*advanced HDMI audio support is not available*).

USB Host Port Provides HID Support

The USB Host (mini-B) port on the front enables USB keyboard and mouse signals from a DXLink RX to be sent to a connected PC.

Additional Buttons and Port

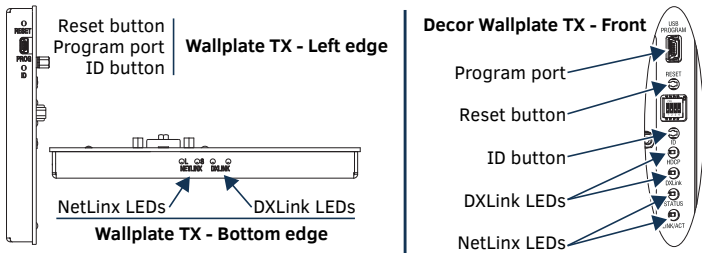

FIG. 9 WALLPLATE TX (LEFT) AND DECOR WALLPLATE TX (RIGHT)

Reset Button

The Reset button resets the Transmitter's CPU (see the *Hardware Reference Manual*).

Program Port

For modules connected to an Enova DGX 8/16/32/64 Switcher, this USB mini-B port supports DGX Configuration Software for programming a custom EDID. For modules connected to an Enova DGX 100 Series Switcher, use the System Configuration interface (see the switcher's manual).

ID Button

The ID button can be used to toggle between static and DHCP IP addressing, assign a device address, reset the factory defaults, and restore the factory default firmware image (see the *Hardware Reference Manual*).

Powering the Wallplate TX and the Decor Wallplate TX

The switcher provides power for the TXs over twisted pair cable. Approved DXLink power sourcing devices are:

- Enova DGX 8/16/32/64
- Enova DGX 800/1600/3200/6400
- Compatible Enova DVX (3155HD or 2155HD)
- PDXL-2 (FG1090-170)*
- PS-POE-AT-TC (FG423-84)*

* Use of PDXL-2 or PS-POE-AT-TC with wallplates requires firmware v1.2.40 or later.

IMPORTANT: AMX does *not* support the use of any other PoE injectors as these may potentially damage the DXLink equipment.

This table shows LED states on initial power up. If not normal, check connections.

INDICATOR LEDS	NORMAL POWER UP	INDICATES
Digital Video*	Green	Configured to pass HDMI with embedded audio
Analog Video*	One of the three LEDs is Green**	Configured to pass analog video: <ul style="list-style-type: none"> • C (composite) or Y/c (two component) • Y/Pb/Pr or RGB (three component) • RGBHV (five component) or RGBS (four component)
Audio*	Green	Configured to pass analog audio (coupled with digital or analog video path)
Power	Green	Power is applied
Wallplate TX LEDs (on bottom edge) and Decor Wallplate TX LEDs (front center)		
NetLinX - L, Link/Act	Green	Unit status
NetLinX - S, Status	Green	Unit status
DXLink - Yellow, HDCP	Yellow Flashing Off	<ul style="list-style-type: none"> • Authenticated HDCP • Video is active; no HDCP • No Video
DXLink - Green	Green	DXLink connection is established

* The LEDs for Digital Video, Analog Video, and Audio each indicate the configured state of the connectors, not necessarily the presence of signals through the Transmitter.

** When an analog video signal is being received from the source device, only one of the three analog video LEDs will be green at any time.

TIP: If the Wallplate TX's location makes the bottom edge difficult to see, slide a white piece of paper or a small mirror under the edge to view LED status.

Signal Precedence

With cables attached to each input on the Transmitters (see FIG. 8), the default precedence for signal transmission is for HDMI with embedded digital audio. To transmit either analog video or analog audio without detaching the HDMI connector, the Transmitter's precedence settings must be changed using SEND_COMMANDS. For information, see the *Hardware Reference Manual*.

Troubleshooting

Try the following and check the *Hardware Reference Manual* before calling technical support.

- Check all power connections in the system.
- Check the RJ-45 (DXLink) cable connection between the Transmitter and the switcher.
- Check the source and destination devices to ensure that they function correctly.

Additional Information Covered in Instruction Manual

For information on the following, see the *Hardware Reference Manual – DXLink Twisted Pair Transmitters/Receiver* at www.amx.com:

- Pinouts for VGA, component, S-Video, and composite
- NetLinX control and programming commands, Telnet commands
- IR file transfers, upgrading firmware image, restoring factory default settings

