

LSE Series

Operating Manual

Genelec 7060B, 7070A and 7071A
Active Subwoofers

GENELEC®





7060B, 7070A and 7071A Active Subwoofers

General description

Genelec 7060B, 7070A and 7071A are powerful active subwoofers, incorporating all the amplifier and crossover electronics needed for bass management and reproduction in modern 6.1 or 5.1 channel surround sound or traditional stereo systems. Their 19 to 120 Hz (± 3 dB) frequency range, ample sound pressure capability and versatile connections make these subwoofers ideal companions for Genelec's active monitoring speakers.

Bass management unit

The built-in bass management unit has six signal input and output channels (L/C/R Front and L/C/R Rear), a discrete LFE signal input and a summed signal output, providing great flexibility and easy connection in all monitoring environments.

The active crossover contained in the bass management unit splits the input signals into low and high frequency components at 85 Hz. Frequencies below 85 Hz are directed to the subwoofer and frequencies above 85 Hz to the main speakers.

The low pass section sensitivity can be adjusted from +12 dBu to -6 dBu to allow

easy subwoofer level matching with various main speakers. All outputs have 0 dB pass-band gain.

The low pass frequency of the LFE input channel can be set to 85 Hz, 120 Hz or 85 Hz with "Redirect" function that routes LFE content above 85 Hz to the front center monitor. The input sensitivity of the LFE channel can be set to 0 dB or +10 dB.

Balanced XLR connectors are used for the system audio inputs and outputs.

Two "Bass Roll-Off" switches are included to provide a flat bass response in all acoustical environments, enabling adjustments of the subwoofer response in three -2 dB steps. Two phase matching switches in the crossover allow compensation for the delay which occurs if the subwoofer is placed away from the main speakers, or for other speaker systems phase behaviour. Four settings are provided between 0° and -270°. An 85 Hz test tone generator is included to help achieve accurate crossover phase alignment.

Installation

Each subwoofer is supplied with a mains cable and an operating manual. Once unpacked, place the subwoofer in a suitable location (for more details see the "Positioning" section).

Before connecting the audio signals, ensure that both the subwoofer and the main monitors are switched off. Check that the voltage selector switch is set according to your local mains voltage (subwoofers sold in Europe have a fixed 230V setting). Connections are easier to make if you roll the subwoofer on its side with the connector panel facing up. Use this position only for making the connections and roll the subwoofer back to its normal upright position before use. Audio connections to the subwoofer are made via balanced XLR connectors. An unbalanced source can also be used with a special RCA to XLR cable; the correct connection for the cable is shown in Fig. 2. However, we recommend the use of balanced cables and connectors due to their better noise immunity. The connectors are arranged in three rows on the connector panel (see Fig. 1):

Top row

LFE IN / SUM IN: Use this connector for the LFE or .1 output channel of a 5.1- or 6.1-channel discrete surround sound source, or the SUM OUT signal from the "master" subwoofer in a daisy-chained multiple subwoofer configuration. Note that the "subwoofer out" channel of an analogue

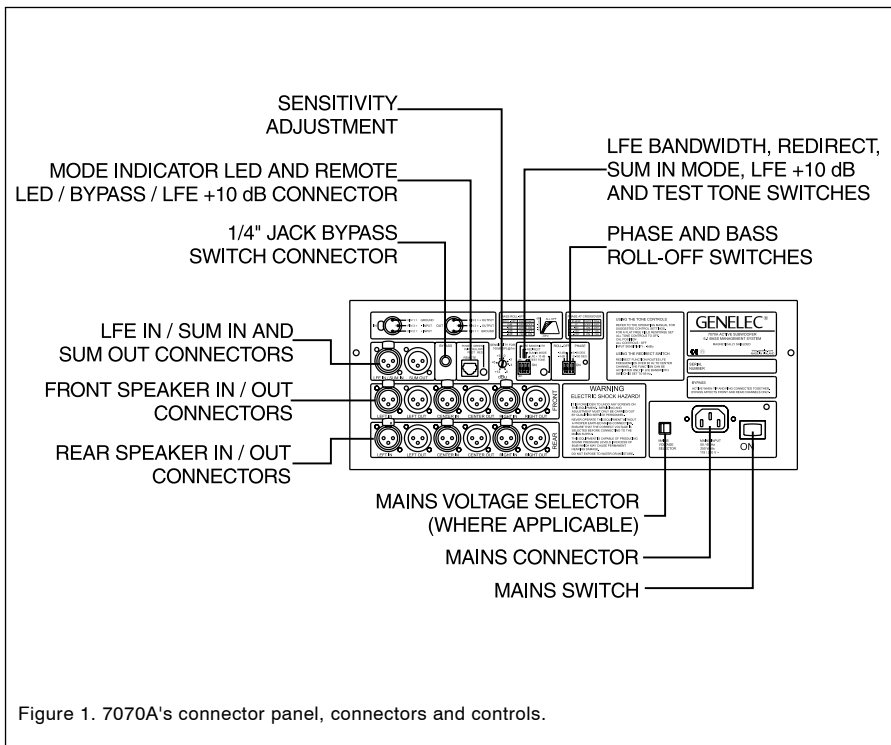

Figure 1. 7070A's connector panel, connectors and controls.

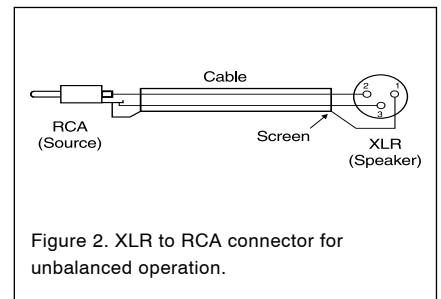

Figure 2. XLR to RCA connector for unbalanced operation.

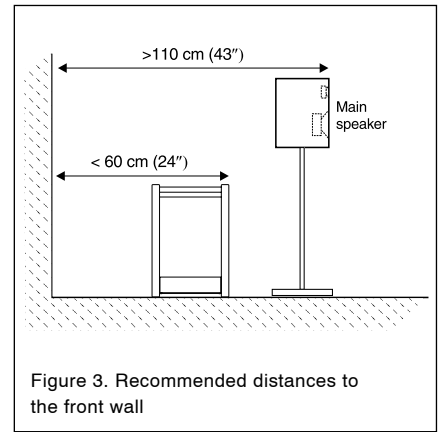

Figure 3. Recommended distances to the front wall

matrix surround decoder (Dolby Surround, Dolby Pro Logic) should not be connected to the "LFE IN" input. See section "Subwoofer in analogue matrix sound systems".

SUM OUT: Use this output connector when you want to link another subwoofer to your system. "SUM OUT" carries an unfiltered sum of signals combined from all input channels. See section "Using multiple subwoofers".

Middle row

FRONT L, C, R CHANNELS IN/OUT: Use these connectors for the Front Left, Center and Right channels of a surround sound system or the Left and Right channels of a Stereo system. Connect line level signal cables from your signal source to their respective "LEFT IN", "CENTER IN" and "RIGHT IN" connectors. Then connect the subwoofer to your main monitors with XLR cables from the "LEFT OUT", "CENTER OUT" and "RIGHT OUT" connectors. All "L, C and R OUT" channels are high pass filtered with the filtering frequency fixed at 85 Hz (12 dB/octave).

Bottom row

REAR L, C, R CHANNELS IN/OUT: Use these connectors for the Rear Left, Center and Right channels of a surround sound

system. The connection is made in the same way as with the Front channels. Also these channels are high pass filtered at 85 Hz.

Once all connections have been made, the subwoofer and main monitors are ready to be powered up.

Positioning in the room

The placement of the subwoofer in the room affects the overall frequency response and sound level of the system dramatically, as at low frequencies the effects of the room are strong. Even a slight change in the subwoofer's location can make a marked difference in the frequency balance and often patient and methodical experimentation and testing is needed to find the optimum placement.

The placement will affect the phase difference between the main monitors and the subwoofer, and also the bass roll-off rate. These effects can be compensated by the use of the controls in the amplifier unit; but we recommend that at first you leave the switches untouched and concentrate on finding the position where the subwoofer gives the smoothest response, and only then use the controls to fine-tune the balance and phase alignment between the subwoofer and the main monitors.

To begin with, place the subwoofer slightly offset from the center of the front wall. The recommended distance to the wall is less than 60 cm / 24" measured from the subwoofer's driver (See Fig. 3). This position gives increased acoustic loading (and SPL) due to the proximity of the front wall and floor. Cancellations from the front wall and floor are also avoided. Front wall cancellation for the 85 Hz high pass filtered main speakers can be eliminated by placing them at least 110 cm / 43" away from the front wall. In a multichannel system the main monitors should ideally be positioned symmetrically and at an equal distance from the listening position.

If the frequency balance is not right, try moving the subwoofer slightly to the left or right so that different room modes are excited at different levels. Positioning the subwoofer close to a corner will boost the bass level at lower frequencies and may cause asymmetrical spatial imaging. If you are using two subwoofers, try placing them asymmetrically relative to the side walls. Sometimes moving the subwoofers apart into the front corners helps with problematic rear wall reflections and the loss of mutual coupling is compensated by the bass boost caused by corner positioning.

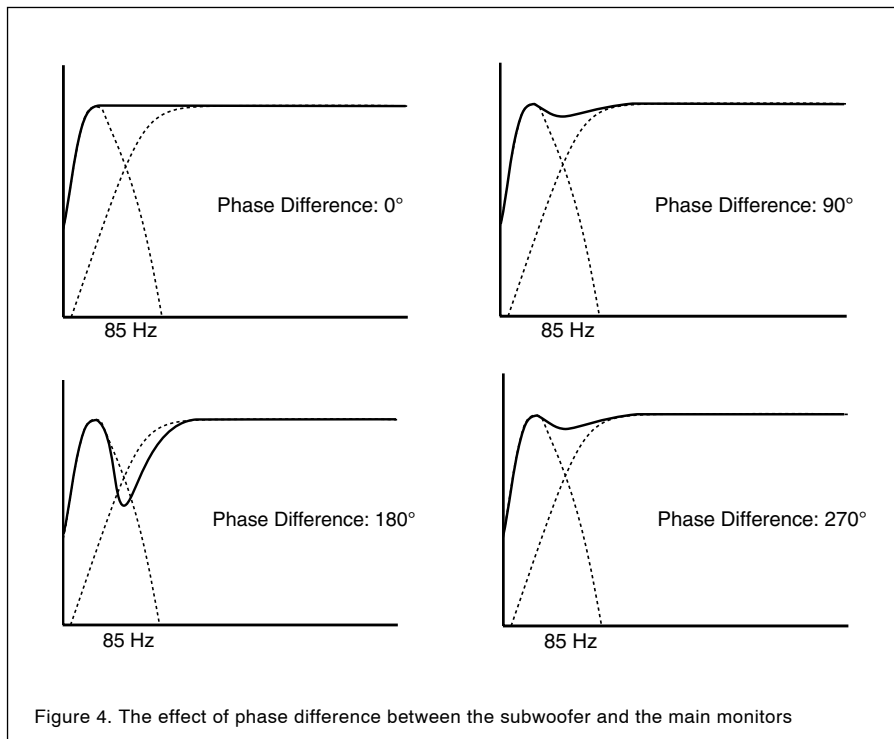

Subwoofer placement	Bass Roll-Off setting
Near to a wall	-2 dB
In a corner	-6 dB
Flush mounted	-2 dB

Table 1. Suggested Bass Roll-Off settings

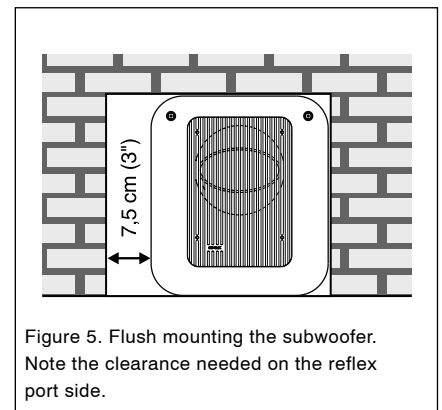

Although the 7060B, 7070A and 7071A subwoofers are magnetically shielded, they may cause some picture distortion if placed near very sensitive video monitors or computer displays. Move the subwoofer further away or try turning the driver side of the subwoofer away from the screen.

Minimum clearances to walls or other objects

The power amplifiers are attached to the lower part of the aluminium grille, which functions as a heatsink. Do not cover the grille or place the subwoofer so that there is less than 10 centimeters (4") of free space in front of the grille.

Make sure that the space underneath the subwoofer is clear from obstructions. Thick carpets may block the ventilation clearance needed for cooling the electronics' box.

The reflex port side (opposite of the connector panel side) should always have a clearance of at least 7,5 centimeters (3") to any objects to ensure proper functioning of the reflex port.

Flush mounting the subwoofer

If the subwoofer is flush mounted into a wall or a cabinet, it is important to ensure unrestricted airflow from the reflex port and ampli-

fier cooling. This can be done by making the recess 7,5 centimeters (3") wider than the subwoofer. Place the subwoofer into the right end of the recess with the driver side facing the room. This leaves sufficient 7,5 centimeters (3") of free space on the reflex port side. The height and depth of the recess should not be any bigger than those needed to fit the subwoofer flush with the wall surface.

Setting the input sensitivity

The subwoofer requires input sensitivity alignment to the source to obtain a correctly balanced system. The input sensitivity control is located on the connector panel of the subwoofer. An input voltage of -6 dBu with a -6 dBu input sensitivity setting will produce 100 dB SPL @ 1m in free field. To obtain a 110 dB SPL output an input voltage of +10 dBu is required when the input sensitivity is set to 0 dBu.

Setting the Bass Roll-Off switches

The acoustic response of the subwoofer may have to be matched to the characteristics of the room and the positioning in which it will be used. To adjust the subwoofer to match these characteristics use the "Bass Roll-Off" control switches located on the connector

panel. Table 1 provides some suggestions for the "Bass Roll-Off" switch settings. When both roll-off switches are set to "OFF", a flat anechoic response is obtained.

Setting the phase control

Incorrect phase alignment between main monitors and subwoofer causes a drop in the frequency response of the whole system at the crossover frequency. The graphs above (Fig. 4) show the effect of phase difference to the frequency response.

The phase difference between the main monitors and subwoofer at the listening position is dependent upon the position of the subwoofer, so the phase adjustment should be done only after the preferred position is found. Acoustic measuring equipment is required for accurate system alignment. If this equipment is not available, the following coarse phase matching can be applied.

Coarse phase adjustment method

Genelec 7060B, 7070A and 7071A subwoofers are equipped with a built-in 85 Hz frequency test tone generator for easy phase alignment. The test tone generator is connected to the subwoofer's "FRONT CENTER OUT" channel only. In a stereo

Maximum room volume, m ³ (ft ³)	Maximum listening distance, m (ft)	Front loudspeakers Stereo & LCR	Side and rear loudspeakers	Subwoofers for 2-channel Stereo	Subwoofers for 5-channel Surround
75 (2,600)	2.0m (6'7")	8030A	8030A	7050B	7060A
75 (2,600)	2.0m (6'7")	8130A	8130A	7050B	7060A ⁽¹⁾
85 (3,000)	2.2m (7'3")	8040A	8040A	7060B	7070A
95 (3,400)	2.3m (7'7")	8050A	8050A	7070A	7070A
110 (3,900)	2.4m (7'10")	1032A	1032A	7070A	7071A
125 (4,400)	3.5m (11'6")	1037C	1037C	7071A	2x7071A
170 (6,000)	4.0m (13'1")	1038B & 1038BC	1038B	7071A	2x7071A
200 (7,000)	4.5m (14'9")	1034B & 1034BC	1038B	7071A	2x7071A ⁽²⁾
240 (8,500)	4.7m (15'5")	1039A	1038B	2x7071A	2x7071A ⁽²⁾
400 (14,000)	5.5m (18'1")	1035B	1038B	2x7071A ⁽²⁾	3x7071A ⁽²⁾
400 (14,000)	5.5m (18'1")	1036A	1038B	⁽³⁾	⁽³⁾

⁽¹⁾ When using a digital input signal, the **8130A** cannot be used with the subwoofer's analogue crossover filters. The subwoofer can be used for reproducing the LFE channel only.

⁽²⁾ Additional subwoofers of the same type may be required in a larger room with bass heavy program material.

⁽³⁾ Subwoofers are not necessarily required for a **1036A** installation as these monitors are already full range. For surround systems, subwoofers can be used to reproduce the LFE channel.

Table 2. Recommended subwoofer/main monitor combinations.

system it is necessary to temporarily connect either of the channels to this output.

Power up the system and set the DIP switches 3 (SUM IN MODE) and 4 (LFE +10 dB) on the first switch group to "ON" Now you should hear an 85 Hz test signal from the subwoofer and the main monitor connected to the center channel output.



Toggle the -180° phase switch (DIP 4 on the second switch group) on and off, and set it to the position which gives the lowest sound level at the listening position.



Next toggle the -90° phase switch (DIP 3) on and off, and again set it to the position which gives the lowest sound level.



Finally, set the -180° phase switch (DIP 4) to the opposite setting and deactivate the test signal.

Phase correction method with test equipment

The following procedure matches the phase between the subwoofer and the main moni-

tors using a frequency analyser and a pink noise generator. Connect a high grade measuring microphone to the analyser and feed pink noise into the "CENTER IN" input of the subwoofer. The subwoofer's bass management system will direct the frequencies above 85 Hz to the center main monitor while the subwoofer reproduces the frequencies below 85 Hz.

Position the microphone at the listening position and adjust the input sensitivity of the subwoofer until frequencies below and above 85 Hz are reproduced at equal level. Then adjust the phase control switches for the maximum dip of at least -6 dB at the crossover frequency (85 Hz).

Change the -180° switch to the opposite setting. The phase should now be set correctly and the frequency analyser should show a smooth response around 85 Hz.

Overload indicators

The mode indicator LED on the connector panel will turn from green to yellow to indicate clipping and then to red to indicate that the protection circuit has activated. If this occurs frequently, reduce the input level to the subwoofer until the LED remains green.

If the LED on the connector panel is not easily visible, the optional Remote LED Kit

can be used to bring it into view. The kit consists of a LED in a compact case and a RJ11 cable to connect the case and the "REMOTE" RJ11 connector on the connector panel.

Subwoofer bypass control

A bypass control feature is included in the subwoofer circuits so that the effect of the subwoofer on the whole monitor system can be determined. With the bypass switch on, the high pass filters for the main monitors are overridden and the system behaves as if the subwoofer was not connected. The bypass function has no effect on the LFE input. Two different bypass remote controllers are available as optional equipment: 1092-400 switch that can be connected to a 1/4" jack connector on the connector panel and 7000-416 that connects to the "REMOTE" RJ11 connector. The 7000-416 option also includes remote control of the "LFE +10 dB" function and a link for the 7000-415 remote LED option.

Subwoofer in analogue matrix surround sound systems.

When using Genelec 7060B, 7070A or 7171A subwoofers in a consumer analogue matrix surround sound system, such as Dolby Surround, Dolby Pro-Logic or Pro-Logic II or a professional matrix decoder such as a Dolby SDU-4, route the front channels through the subwoofer so that the output of the subwoofer is matched to the rest of the system and select "Large" setting for the front speakers on the decoder. If there is a subwoofer channel output on the decoder it should NOT be connected to the subwoofer's "LFE IN" input since the processing within an analogue decoder will conflict with the filtering in the subwoofer. Connecting the rear channels to the subwoofer is optional since the rear channels from most matrix decoders are band limited down to 100 Hz.

Monitoring the LFE channel in digital discrete surround sound systems

Some digital surround sound systems use a discrete Low Frequency Effects channel which should be connected to the "LFE IN" input on the connector panel. This enables the subwoofer to correctly reproduce all the bass information in the mix.

The LFE channel on the 7060B, 7070A and 7071A can be set to two frequency ranges: 19 to 85 Hz or 19 to 120 Hz by using the "LFE BANDWIDTH" switch. If the LFE signal includes higher frequencies than 120 Hz, they can be monitored by using the "Redirect" function: Set "LFE BANDWIDTH" switch to "85" and the "REDIRECT" switch to "ON". Now the subwoofer reproduces LFE frequencies up to 85 Hz and reroutes all higher LFE content to the front center channel. This is the most flexible setting for LFE signal management, as it ensures that all LFE content can be monitored in all situations and encoding formats. Note that the "Redirect" function is not enabled when the "LFE BANDWIDTH" switch is set to 120 Hz.

Typical applications of different LFE bandwidth settings

As stated above, using the 85 Hz LFE bandwidth setting with "Redirect" function is the most universal configuration for LFE monitoring. However, there are situations when the band-limited LFE settings serve a definite purpose.

Limiting the LFE bandwidth to 85 Hz without using the "Redirect" function can be used to simulate the effect of some consumer decoders that do not replay information above 80 Hz on the LFE channel when the bass management is used. Checking the multichannel mix with this setting on lets you know how it translates in systems with this limitation.

The 120 Hz LFE bandwidth setting complies with the replay systems of movie theaters and cinemas. 35 mm movie soundtracks use the LFE channel to reproduce a bandwidth of 20 - 120 Hz through dedicated subwoofers. In this case the LFE and main channel bandwidths overlap between 85 and 120 Hz, which may create unwanted acoustical summing if the same signal is present in both channels. To avoid this, the LFE content should be kept completely different (decorrelated) from the low frequency content of the main channels when mixing music and sound effects for film release.

Using the LFE +10 dB function

In Dolby Digital and DTS encoding formats the LFE channel has to be monitored with

+10 dB gain in relation to the main channels. The object is to increase the recording headroom of the LFE channel. Consumer and theatrical decoders automatically add +10 dB of LFE gain to restore the level balance.

The "LFE +10 dB" function on the 7060B, 7070A and 7071A subwoofers is designed to add the +10 dB gain to the LFE channel in the production stage, if it is not already done in the output matrix of the mixing console. The function is activated by switching the "LFE +10 dB" dip switch on the subwoofer's first switch group to "ON" or by using the remote control. A yellow LED indicates that the function has been activated.

The "LFE +10 dB" function should **not** be used in following cases:

- If the +10 dB LFE gain is already implemented by another device.
- When producing an audio format that does not require the use of +10 dB gain on the LFE channel, such as DVD-Audio (MLP), SACD (DSD) etc.
- When monitoring a decoded Dolby Digital or DTS soundtrack. The decoder will automatically provide +10 dB LFE gain.

Using multiple subwoofers

Genelec 7060B, 7070A and 7071A subwoofers are equipped with a "SUM OUT" connector to provide an easy way of coupling two or more subwoofers together in high SPL applications. Table 2 shows the recommended configurations with different Genelec monitors. Connect an XLR cable from the "SUM OUT" connector of the "master" subwoofer to which the main monitor channels are connected, to the "LFE IN / SUM IN" connector of the other, "slave" subwoofer and turn the "SUM IN MODE" dip switch on the "slave" subwoofer to "ON".

When two subwoofers connected in this way are positioned close to one another, bass level increases by 6 dB. Three subwoofers give an SPL increase of 9,5 dB and four subwoofers 12 dB compared to a single subwoofer. Adjust the sensitivity control of all subwoofers in the group to match the SPL level of the main monitor system.

Phase and Bass Roll-Off adjustments should be done individually for each sub-

woofer in the chain, especially if they are not placed close together. To check the phase alignment for the "master" subwoofer switch off the "slave" subwoofer and follow the instructions given in the previous sections.

To adjust the phase alignment of the "slave" subwoofer, you need to switch off the "master" subwoofer, connect a signal cable from the "slave" subwoofer's "FRONT CENTER OUT" connector to the center channel monitor and switch the "SUM IN MODE" switch to "OFF". This effectively changes the "slave" to "master" mode and the phase adjustment can be carried out. Return the connections and "SUM IN MODE" setting on the "slave" subwoofer back to the "SUM IN" mode after completing the adjustment.

Safety considerations

The LSE series subwoofers have been designed in accordance with international safety standards. However, to ensure safe operation and maintain the unit in safe operating condition, the following warnings and cautions must be observed:

- Do not expose the subwoofer to water or moisture. Do not place any objects filled with liquid, such as vases on the subwoofer or near it.
- Do not place naked flame sources like lighted candles on or near the subwoofer
- Servicing and adjustment must only be performed by qualified service personnel.
- Opening the connector panel is strictly prohibited except by qualified service personnel.
- Always use a mains power connection and cable with protective earth. Failing to do this may lead to personal injury.
- Note that the amplifier is not completely disconnected from the AC mains service unless the mains power cord is removed from the amplifier or the mains outlet.

Warning!

This equipment is capable of delivering sound pressure levels in excess of 85 dB, which may cause permanent hearing damage.



Figure 6. 1092-400 "Bypass" switch



Figure 7. 7000-415 Remote Power/OVL LED



Figure 8. 7000-416 Remote control switch for "Bypass" and "+10 dB LFE" functions

Maintenance

No user serviceable parts are inside the amplifier unit. Any maintenance work must only be performed by qualified service personnel.

Guarantee

This product is supplied with a one year guarantee against manufacturing faults or defects that might affect the performance of the unit. Refer to supplier for full sales and guarantee terms.

Accessories

- 1092-400 1/4" jack "Bypass" switch
- 7000-415 RJ11 remote Power/Overload indicator LED
- 7000-416 RJ11 remote control for "Bypass" and "+10 dB LFE" functions

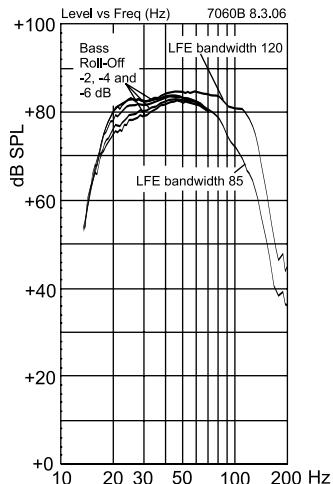

Figure 9. The free field frequency response of the 7060B subwoofer at different Bass Roll-Off settings

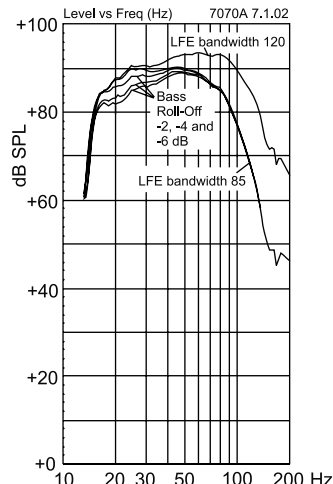

Figure 10. The free field frequency response of 7070A and 7071A subwoofers at different Bass Roll-Off settings.

EC Declaration of Conformity

This is to certify that Genelec 7060B, 7070A and 7071A active subwoofers conform to the following standards:

Safety:

EN 60065 / IEC 60065:1998 7th Edition

EMC:

EN 55013: (2001)

EN 55020: (1994), A11: (1996), A12: (1999),

A13: (1999), A14: (1999)

EN 61000-3-2 (2000), EN 61000-3-3 (1995)

The products herewith comply with the requirements of The Low Voltage Directive 73/23/EEC, EMC Directive 89/336/EEC and 93/68/EEC

Signed: 

Ilpo Martikainen

Position: Chairman of the Board

Date: 28-February-2006

7060B, 7070A and 7071A Operating Manual

SYSTEM SPECIFICATIONS

	7060B	7070A	7071A
Free field frequency response (+/- 3 dB)	19 Hz...85 Hz LFE 85/120 Hz	19 Hz...85 Hz LFE 85/120 Hz	19 Hz...85 Hz LFE 85/120 Hz
Maximum short term sine wave SPL output averaged from 30 to 85 Hz, measured in half space at 1 meter	≥ 108 dB SPL	≥ 112 dB SPL	≥ 118 dB SPL
Maximum peak SPL output with random pink noise, measured in half space at 1 meter	≥ 113 dB SPL	≥ 117 dB SPL	≥ 123 dB SPL
Self generated noise level in free field @ 1 m on axis (A-weighted)	≤ 15 dB		
Harmonic distortion at @ 1 m on axis in half space 2nd 3rd	@ 90 dB SPL 30 ... 85 Hz ≤ 3 % ≤ 2 %	@ 95 dB SPL 30 ... 85 Hz ≤ 3 % ≤ 3 %	@ 100 dB SPL 30 ... 85 Hz ≤ 3 % ≤ 3 %
Driver, magnetically shielded	250 mm (10")	305 mm (12")	2 x 305 mm (12")
Weight	26 kg (57 lbs)	50 kg (110 lbs)	81 kg (178 lbs)
Dimensions Height Width Depth	527 mm (20 3/4") 462 mm (18 3/16") 363 mm (14 5/16")	625 mm (24 5/8") 555 mm (21 7/8") 490 mm (19 5/16")	755 mm (29 3/4") 803 mm (31 5/8") 490 mm (19 5/16")

CROSSOVER SECTION

	7060B	7070A	7071A
Subsonic filter (18 dB/octave) below	19 Hz	19 Hz	19 Hz
Crossover frequency, (sub/main channels)	85 Hz		
LFE cutoff Hz	85 Hz/120 Hz selectable		
Crossover slopes Lowpass Highpass	36 dB/octave 12 dB/octave		
Midband rejection >400 Hz	≥ 50 dB		
Bass Roll-Off control operating range in 2 dB steps	From 0 to -6 dB @ 20 Hz	From 0 to -6 dB @ 20 Hz	From 0 to -6 dB @ 20 Hz
Phase matching control in 90° steps	From 0 to 270 @ 85 Hz		

AMPLIFIER SECTION

	7060B	7070A	7071A
Short term amplifier output power (Long term output power is limited by driver unit protection circuitry)	120 W	250 W	500 W
Amplifier system distortion at nominal output THD	≤ 0.05%		
Mains voltage	230 V, 115/230V or 100/200V according to region		
Power consumption (average) Idle Full output	15 VA 150 VA	15 VA 250 VA	30 VA 500 VA

INPUT SECTION

	7060B	7070A	7071A
Input connector XLR female pin 1 pin 2 pin 3	gnd + -		
Input impedance	10 kOhm balanced		
Input level for 100 dB SPL output @ 1 m	Variable from +12 to -6 dBu		

OUTPUT SECTION

	7060B	7070A	7071A
Output connector XLR male pin 1 pin 2 pin 3	gnd + -		
Remote LED connector (RJ11)	Remote LED for Power/Overload+Bypass and LFE +10 dB		
Main monitor Out gain	0 dB		
Sum Out gain	0 dB		

CONTROLS

	7060B	7070A	7071A
Input sensitivity	+12 to -6 dBu for 100 dB @ 1 m		
Bypass	Bypasses the bass management for the main channels		
LFE bandwidth	85 / 120 Hz		
LFE sensitivity	0 / +10 dB		
Redirect	Redirects LFE channel signal above 85 Hz to center channel		
Sum in	Changes subwoofer to Sum in mode		
Test tone for phase adjustment	85 Hz		
Bass Roll-Off	0/-2 dB/ -4 dB/ -6 dB @ 20 Hz	0/-2 dB/ -4 dB/ -6 dB @ 20 Hz	0/-2 dB/ -4 dB/ -6 dB @ 20 Hz
Phase	0/90/180/270° @ 85 Hz		