

# 1037C and 1038B

Operating Manual  
Genelec 1037C and 1038B  
Tri-amplified Monitoring Systems

# GENELEC®





## Genelec 1037C and 1038B Tri-amplified Monitoring Systems

### System

The Genelec 1037C and 1038B are three-way active monitoring systems including drivers, multiple power amplifiers and active crossovers. The systems are designed for medium sized control rooms and suited for music recording studios, film and video post-production and general broadcasting monitoring as well as for mastering suites. They are designed to perform well both as free-standing monitors or flush mounted into the control room wall.

The unique Directivity Control Waveguide™ (DCW™) Technology developed by Genelec provides excellent stereo imaging and frequency balance even in difficult acoustic environments. The fast, low distortion amplifiers are capable of driving the stereo system to peak output levels in excess of 124 dB SPL at 2 m (1038B) or 126 dB SPL at 1.7 m (1037C) with program material. Versatile crossover controls allow for precise matching of the speaker system to different acoustic conditions.

### Drivers and cabinet construction

On the 1038B the low frequencies are reproduced by an 385 mm (15") bass driver loaded

with a 110 liter vented box. The -3dB point is 33 Hz and the low frequency response extends down to 29 Hz (-6 dB). The 1037C features a 305 mm (12") bass driver in a 65 liter vented box with the -3 dB point at 35 Hz and -6 dB at 32 Hz.

Both models share the same midrange and high frequency driver layout with a proprietary 130 mm (5") direct radiating cone for the MF and a 25 mm (1") metal dome for the HF loaded by proprietary Directivity Control Waveguide. All drivers are magnetically shielded.

### Crossover filters

The active crossover network consists of three parallel bandpass filters. The crossover frequencies are 410 Hz and 3.0 kHz on the 1038B and 420 Hz and 3.2 kHz on the 1037C. Bass, midrange and treble level controls with 1 dB steps are included in the crossover to obtain uniform frequency balance in different acoustic conditions. The low frequency Tilt and Roll-off controls both have four 2 dB steps to allow refined low frequency response tailoring. The crossover network is driven by an active balanced input stage, fed by a 3 pin XLR connector. Variable input sensitivity allows for accurate level matching to console output section.

### Amplifiers

The bass, midrange and treble amplifiers on the 1038B produce 400 W, 120 W and 120 W of short term power. The 1037C has a 180 W amplifier for the low frequency driver and 120 W amplifiers each for midrange and treble drivers. The amplifiers are designed to operate at very low THD and IM distortion values and incorporate special circuitry for driver overload protection and amplifier thermal protection.

### Installation

Each monitor is supplied with an integrated amplifier unit, a mains cable and an operating manual. Once unpacked place the loudspeaker in its required listening position, taking note of the line of the listening axis (see Figure 1).

Sufficient cooling for the amplifier must be ensured. The minimum clearance for the amplifier is 10 centimeters (4") to any object. The space adjacent to the amplifier must either be ventilated or sufficiently large to dissipate heat so that the ambient temperature does not rise above 35 degrees Celsius (95°F). If the speaker is flush mounted into the wall structure, the amplifier can be placed separately into an equipment rack using an

| Speaker mounting position             | Bass roll-off | Bass tilt | Bass level | Midrange level | Treble level |
|---------------------------------------|---------------|-----------|------------|----------------|--------------|
| Free anechoic response                | None          | None      | None       | None           | None         |
| Free standing in a damped room        | None          | -2 dB     | None       | None           | None         |
| Free standing in a reverberant room   | None          | -2 dB     | -2 dB      | None           | None         |
| In a corner                           | -2 dB         | -2 dB     | -2 dB      | None           | None         |
| Soffit mounted in a control room wall | None          | None      | -4 dB      | None           | None         |

Table 1. Suggested tone control settings for different acoustic environments

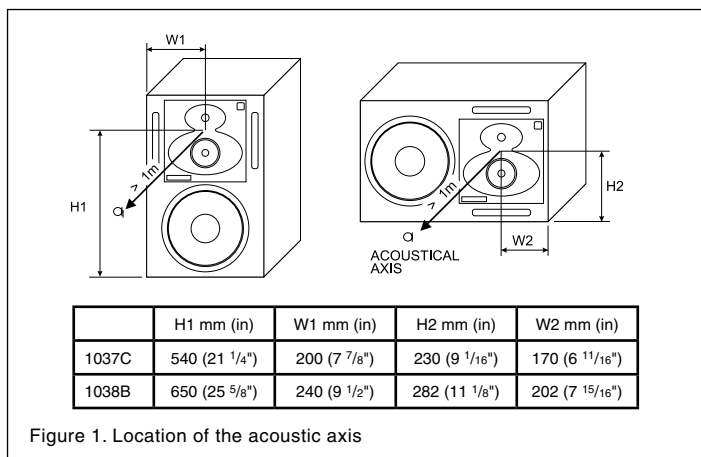

Figure 1. Location of the acoustic axis

optional rack mount kit (see sections 'Flush mounting' and 'Accessories').

Before connecting up, ensure that the mains switch is off (see Figure 2). Check that the mains voltage selector is correctly set to your local voltage. Audio input is made via a 10kOhm balanced XLR connector, but unbalanced leads may be used as long as pin 3 is grounded to pin 1 of the XLR. Once connection has been made, the speakers are ready to be powered-up.

### Setting the input sensitivity

Adjustment of the input sensitivity of each speaker can be made to match the output of the mixing console or other source, by use of the input sensitivity control on the rear panel (see Figure 2). A small screwdriver is needed for the adjustment. The manufacturer default setting for this control is -6 dBu (fully clockwise) which gives an SPL of 100 dB @1m with -6 dBu input level. To get the full output level of 120 dB SPL from the 1038B an input level of +14 dBu is needed at this setting. Respectively, the full output level of the 1037C is reached at an input level of +10 dBu.

### Setting tone controls

The acoustic response of the system may also have to be adjusted to match the acoustic

environment. The adjustment is done by setting the five tone control switch groups 'bass tilt', 'bass roll-off', 'bass level', 'mid level' and 'treble level' on the rear panel of the amplifier. The manufacturer's default settings for these controls are 'All Off' to give a flat anechoic response. See Table 1 for suggested tone control settings in differing acoustic environments. Figures 7 and 8 show the effect of the controls on the anechoic response. Always start adjustment by setting all switches to the 'OFF' position. Then set only one switch per group to the 'ON' position to select the response curve required. If more than one switch is set to 'ON' (within one switch group) the attenuation value is no longer accurate.

### Vertical / horizontal mounting

The speakers are delivered either for vertical or horizontal mounting. In the horizontal mounting position the bass drivers should point inwards to obtain better low frequency coupling. If the speaker positioning needs to be changed, the DCW plate can be rotated so that the midrange driver remains always located at the bottom of the DCW. Remove the four corner screws of the DCW and pull the plate carefully out without stressing the wires and the gasket. Rotate the plate 90 degrees in the appropriate direction and

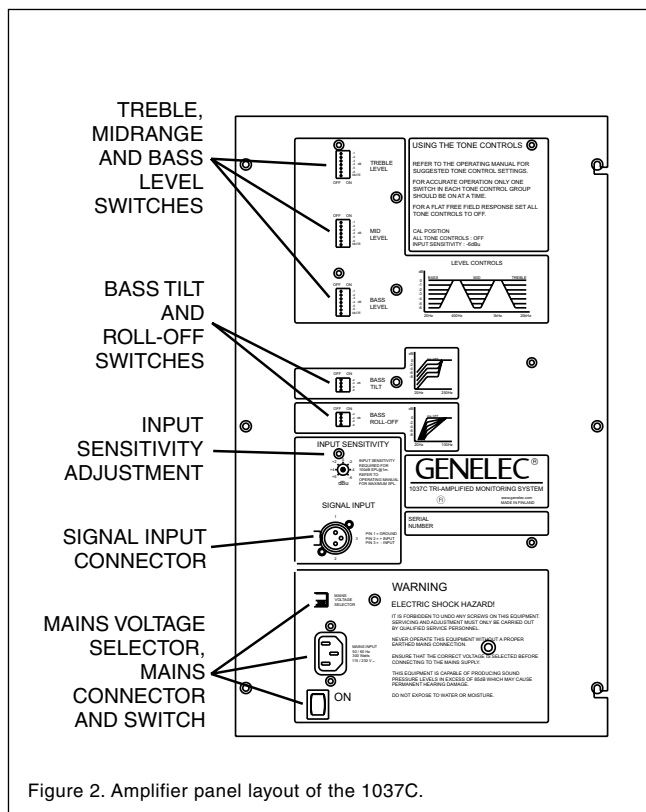

Figure 2. Amplifier panel layout of the 1037C.

remount the screws.

### Flush mounting

The 1037C and 1038B can be used flush mounted into the control room wall, which offers some acoustical benefits. No cabinet edge diffraction will occur, resulting in an improved response, especially at midrange frequencies. Low frequency reflections from the wall behind the speaker can be avoided, which improves the low frequency response and efficiency and allows the speaker to work in half space conditions. In terms of installation and orientation, the speaker's acoustical axis (See Figure 1.) should also point directly to the listening position. The speaker should be vertically aimed so that the acoustical axis of the two speakers meet midway between the standing and seated listening position (1.4m - 4'7" from the floor). In the horizontal plane the speaker should be positioned according to the standard stereophonic (60 degrees between left-right channels) or multichannel (ITU-R BS.775-1) placement recommendation.

The ceiling, side walls and especially the rear wall should be acoustically absorbent at low frequencies. The wall in which the speakers are mounted should have a high acoustical mass to properly implement a low

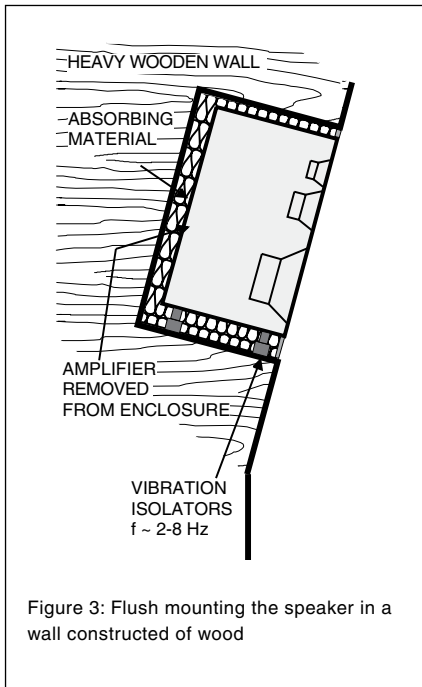

frequency radiation condition into half space and be angled so that the speakers are correctly aimed. However, the speakers should not be mounted too high as this increases the required vertical tilt of the speaker (maximum tilt angle < 20 degrees) and reduces the optimum listening area. Great care should be taken over how the speaker is mounted into the wall. Note the following:

A space 50 to 100 mm (2 to 4") wide can be left around the speaker. Cover the space around the speaker with a facing panel that should be fixed to the wall. Leave a gap of about 5 to 10 mm (1/4 to 1/2") between the speaker and the panel. Fill this gap with a soft rubber gasket to allow for possible cabinet movement (see Figure 6).

Ensure that the speaker cables can reach the rear of the speaker cabinets.

Regardless of the type of front wall construction the speaker cabinet should be mounted on vibration isolators, with a resonant frequency between 2 to 8 Hz, to prevent vibrations from being transmitted to the wall and impairing the low frequency performance.

If a heavy wooden front wall construction is used, the space around the cabinet should be filled with absorbent mineral wool or foam plastic. The wooden wall structure must be heavily braced to achieve sufficiently high mass and rigidity (see Figure 3).

In a solid wall (e.g. concrete) structure, the

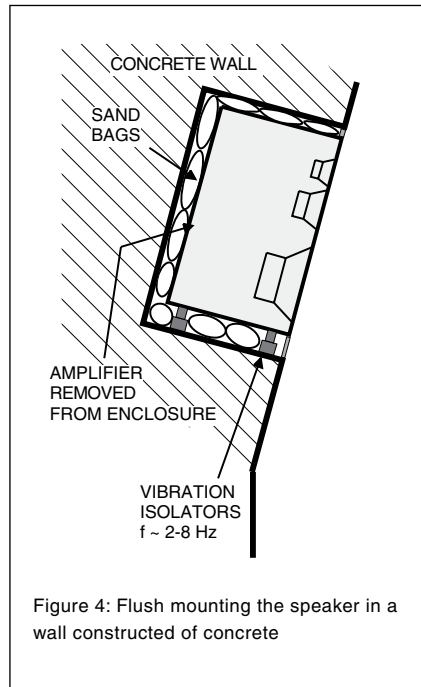

space around the cabinet should be filled with either absorbent mineral wool or sand bags (see Figure 4).

The wall can also be constructed of a combination of materials to achieve high acoustical structural mass that will disable low frequency sound propagation and provide high LF sound isolation (see Figure 5). Acoustic consultants will be able to provide details and design these structures.

Ensure that the cabinet is flush with the surface of the wall. Discontinuities in the speaker mounting wall will cause diffraction, which leads to inferior frequency response and stereo imaging. So, if a decorative cloth frame is used to cover the wall, make sure that the edges adjacent to the speaker are less than 20 mm (3/4") deep. The cloth must be very thin Tricot or an acoustically transparent material otherwise the high frequency response of the system will be adversely affected. Genelec approved cloth grilles are available.

### Overload indicators

The speaker is provided with two indicator LED's marked 'CLIP PROTECT (FAULT)' and 'READY' (1038B) or 'ON' and 'OVL' (1037C). The green LED indicates that the speaker is ready for use. The red LED indicates that the amplifier is overloaded or the driver protection circuit is activated. In both cases reduce the signal level so that the LED stops blinking. If the red LED stays on constantly it indi-

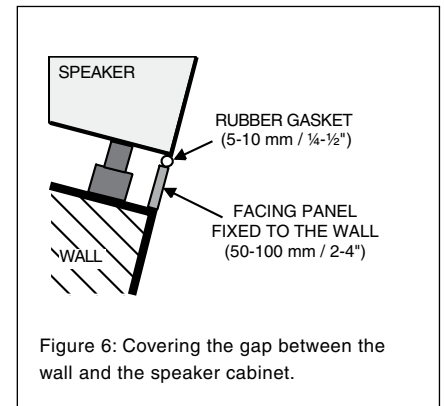
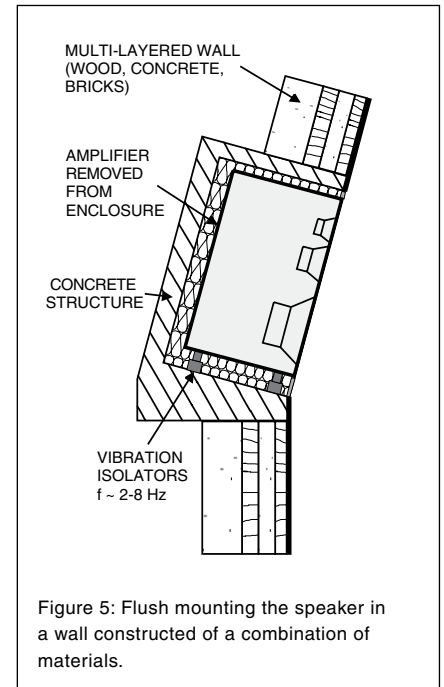

cates that the amplifier thermal protection is activated. Let the amplifier cool down and check that the ventilation around the amplifier is not blocked. There should be a clearance of more than 100 mm (4") between the amplifier face panel and any solid surface at the back.

### Maintenance

No user serviceable parts are to be found within the amplifier unit. Any maintenance or repair should only be undertaken by qualified service personnel. Ensure that if fuse replacement is required, only fuses of the same voltage and current rating are used. Remember to disconnect the power supply by removal of the mains cable, before fuse replacement.

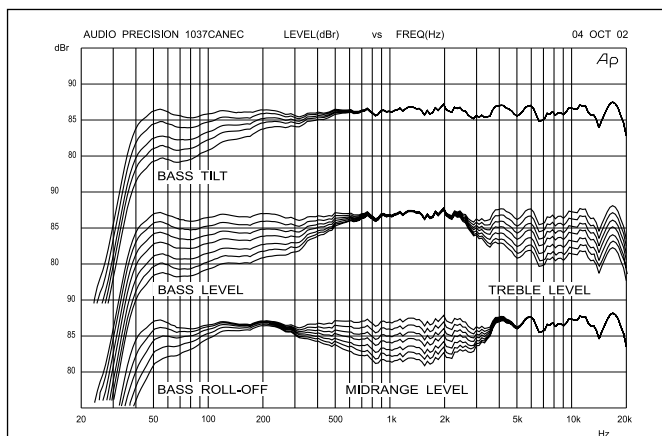

Figure 7: The curves above show the effect of the 'bass', 'mid' and 'treble' level controls, and the 'bass tilt' and 'bass roll-off' controls on the free field response of the 1037C, measured at 2 m.

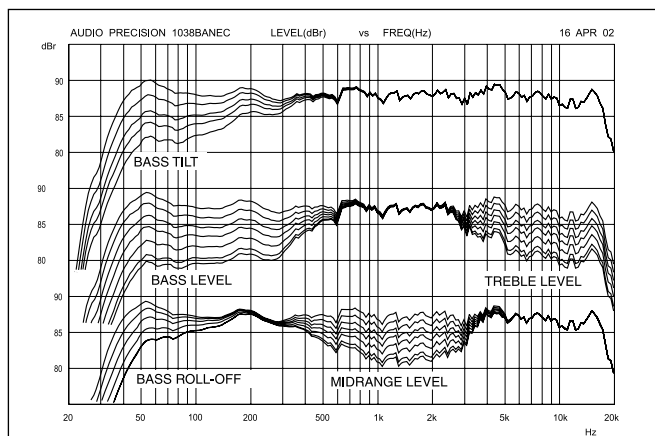

Figure 8: The curves above show the effect of the 'bass', 'mid' and 'treble' level controls, and the 'bass tilt' and 'bass roll-off' controls on the free field response of the 1038B, measured at 2 m.

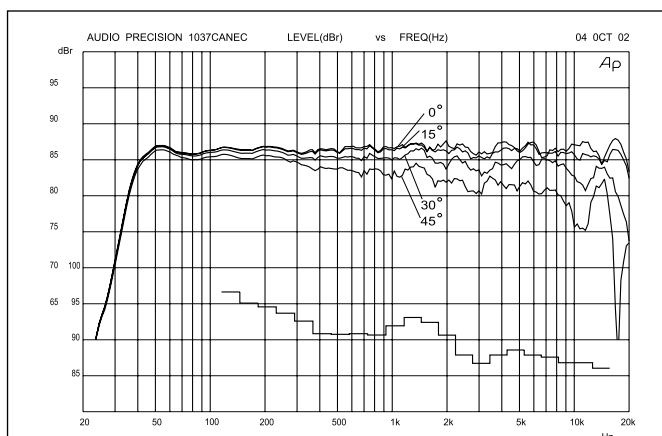

Figure 9: The upper curve group shows the horizontal directivity characteristics of the 1037C in its vertical configuration measured at 2 m. The lower curve is a 1/6 octave power response measurement, derived from 144 individual directivity measurements.

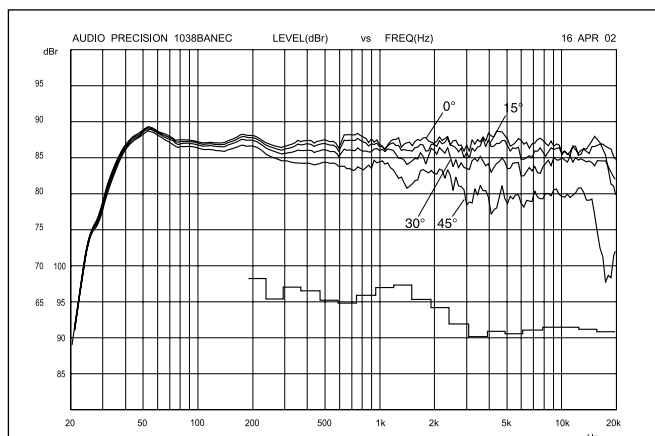

Figure 10: The upper curve group shows the horizontal directivity characteristics of the 1038B in its vertical configuration measured at 2 m. The lower curve is a 1/6 octave power response measurement, derived from 144 individual directivity measurements.

### Safety considerations

Although the 1037C and 1038B monitors have been designed in accordance with international safety standards, to ensure safe operation and to maintain the instrument under safe operating conditions, the following warnings and cautions must be observed:

1. Servicing and adjustment must only be performed by qualified service personnel. The amplifier's rear panel must not be opened.
2. Do not use this product with an unearthed mains cable as this may lead to personal injury.
3. To prevent fire or electric shock, do not expose the unit to water or moisture. Do not place any objects filled with liquid,

- such as vases on the speaker or near it.
4. Note that the amplifier is not completely disconnected from the AC mains service unless the mains cable is removed from the amplifier or the mains outlet.

**WARNING!**

These speakers are capable of producing sound pressure levels in excess of 85 dB, which may cause permanent hearing damage.

### Guarantee

This product is supplied with one year guarantee against manufacturing faults or defects that might alter its performance. Refer to supplier for full sales and guarantee terms.

### 1037C Accessories

|                   | Order code |
|-------------------|------------|
| Wall mount        | 1037-404   |
| Floor stand       | 1037-405   |
| Handles           | 1001-406*  |
| Protective grille | 1037-409   |
| Rack adapter      | 1037-412   |

\* Factory installed option only

### 1038B Accessories

|                   | Order code |
|-------------------|------------|
| Floor stand       | 1038-405   |
| Handles           | 1001-406*  |
| Protective grille | 1038-409   |
| Rack adapter      | 1038-421   |

\* Factory installed option only

# 1037C and 1038B Operating Manual

## SYSTEM SPECIFICATIONS

|  | 1037C  | 1038B  |
|--|--|--|
| Lower cut-off frequency, -3 dB<br>Upper cut-off frequency, -3 dB<br>Free field frequency response of system                  | ≤35 Hz<br>≥22 kHz<br>37 Hz - 21 kHz (±2.5 dB)                  | ≤33 Hz<br>≥20 kHz<br>35 Hz - 20 kHz (±2.5 dB)                  |
| Maximum short term sine wave acoustic output on axis in half space, averaged from 100 Hz to 3 kHz                            | @ 1m ≥116 dB SPL   | @ 1m ≥120 dB SPL   |
| Maximum long term RMS acoustic output in same conditions with IEC-weighted noise (limited by driver unit protection circuit) | @ 1m ≥107 dB SPL   | @ 1m ≥116 dB SPL   |
| Maximum peak acoustic output per pair above console with music material  | @ 1.7m ≥126 dB   | @ 2m ≥124 dB   |
| Self generated noise level in free field @ 1m on axis  | ≤15 dB (A weighted)  |  |
| Harmonic distortion at 95 dB SPL at 1m on axis:  | freq. 50...100 Hz <3%<br>freq. >100 Hz <0.5%                   | freq. 50...100 Hz <1%<br>freq. >100 Hz <0.5%                   |
| Drivers<br>Bass<br>Midrange<br>Treble<br>All drivers are magnetically shielded   | 305 mm (12") cone<br>130 mm (5") cone<br>25 mm (1") metal dome | 385 mm (15") cone<br>130 mm (5") cone<br>25 mm (1") metal dome |
| Weight   | 37 kg (82 lb)  | 60 kg (130 lb)   |
| Dimensions<br>Height<br>Width<br>Depth   | 680 mm (26 3/4")<br>400 mm (15 3/4")<br>380 mm (15")           | 810 mm (32")<br>480 mm (18 9/10")<br>420 mm (16 1/2")          |

## CROSSOVER SECTION

|  | 1037C   | 1038B  |
|--|---|--|
| Input connector XLR female   | pin 1 gnd<br>pin 2 +<br>pin 3 -   |  |
| Input impedance  | 10 kOhm   |  |
| Input level for 100 dB SPL output @ 1m   | variable from +6 to -6 dBu  |  |
| Input level for maximum short term output                                      | variable from +22 to +10 dBu for 116 dB SPL @ 1m  | variable from +26 to +14 dBu for 120 dB SPL @ 1m |
| Subsonic filter  | 18 dB/octave below 35 Hz  | 18 dB/octave below 33 Hz                         |
| Ultrasonic filter  | 12 dB/octave above 25 kHz   |  |
| Crossover frequency<br>Bass/Mid<br>Mid/Treble                                  | 420 Hz<br>3.2 kHz   | 410 Hz<br>3 kHz                                  |
| Crossover acoustical slopes  | 18 - 24 dB/octave   | 24 - 32 dB/octave                                |
| Crossover level control operating range in 1 dB steps<br>Bass<br>Mid<br>Treble | from 0 to -6 dB<br>from 0 to -6 dB<br>from 0 to -6 dB   |  |
| Bass roll-off control in 2 dB steps  | from 0 to -8 dB @35 Hz  | from 0 to -8 dB @33 Hz                           |
| Bass tilt control in 2 dB steps  | from 0 to -8 dB @80 Hz<br><br>The 'CAL' position is with all tone controls set to 'off' and input sensitivity control to maximum. |  |

## AMPLIFIER SECTION

|  | 1037C  | 1038B              |
|--|--|--------------------|
| Bass amplifier short term output power   | 180 W (4 Ohm load)   | 400 W (8 Ohm load) |
| Midrange amplifier short term output power with an 8 Ohm load                          | 120 W  |                    |
| Treble amplifier short term output power with an 8 Ohm load                            | 120 W  |                    |
|  | Long term output power is limited by driver unit protection circuitry. |                    |
| Slew rate  | 80V/μs   |                    |
| Amplifier system distortion at nominal output<br>THD<br>SMPTE-IM<br>CCIF-IM<br>DIM 100 | ≤0.05%<br>≤0.05%<br>≤0.05%<br>≤0.05%                                   |                    |
| Signal to Noise ratio, referred to full output<br>Bass<br>Midrange<br>Treble           | ≥100 dB<br>≥100 dB<br>≥100 dB  |                    |
| Mains voltage  | 100/200V or 115/230V   |                    |
| Voltage operating range  | nominal ±10%   |                    |
| Power consumption<br>Idle<br>Full output   | 50 W<br>300 W  | 60 W<br>500 W      |

# GENELEC®

International enquiries:  
Genelec, Olvitie 5  
FIN-74100, Iisalmi, Finland  
Phone +358 17 83881  
Fax +358 17 812 267  
Email genelec@genelec.com

In the U.S. please contact:  
Genelec, Inc., 7 Tech Circle  
Natick, MA 01760, USA  
Phone +1 508 652 0900  
Fax +1 508 652 0909  
Email genelec.usa@genelec.com

In China please contact:  
Beijing Genelec Audio Co.Ltd  
Jianwai SOHO, Tower 12,  
Room 2605  
D-1504, Chaoyang District  
Beijing 100022, China  
Phone +86 10 8580 2180  
Fax +86 10 8580 2181  
Email genelec.china@genelec.com